

Congratulations and thanks for your purchase! This booklet will tell you everything you need to properly assemble your tent and maintain it.

Follow these instructions carefully and you'll enjoy many years of use – please note that this product is intended for mild, 3 season, family camping use and not for extreme conditions of weather and use

1

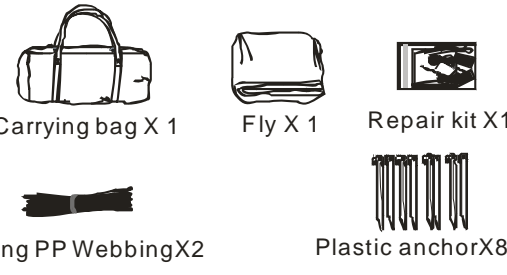

Carrying bag X 1 Fly X 1 Repair kit X 1

Long PP Webbing X 2 Plastic anchor X 8

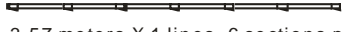

3.57 meters X 1 lines, 6 sections per line (for green sleeves)



5.27 meters X 1 lines, 9 sections per line (for blue sleeves)

2

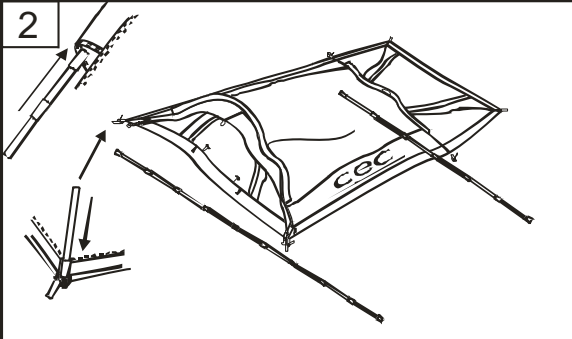

a) Lay the rain fly on the ground as flat as possible.
B) Insert the assembled fibreglass pole through the fly sleeve. Long pole to the left and short pole to the right pole sleeves respectively.
c) Insert the corresponding pins (located at the bottom edges of the rain fly) into the ends of each pole.

3

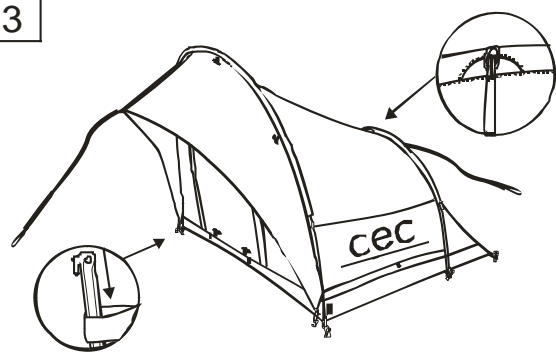



a) Stake the corners by using the plastic anchor.
b) Tie the pp webbing as showed in the sketch.

4

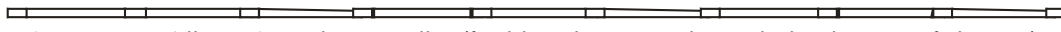

Stake down the pp webbing.

-   3.57 meters x 1 lines, 6 sections per line (for green sleeves, color coded at bottom of sleeves)
-   5.27 meters x 1 lines, 9 sections per line (for blue sleeves, color coded at bottom of sleeves)

CARING FOR YOUR TENT:

- Keep it clean: Don't set up your tent in the mud, avoid putting muddy clothing and gear in the sleeping compartments as sand and dirt can scratch the water proof coating and damage zippers
- UV light can accelerate fabric degradation. Therefore, set up your tent in the shade when possible and use the rain fly to protect the inner tent
- To prolong the life of your tent floor, we recommend the use of a tent footprint or separate sheet of PE (tarpaulin) fabric underneath the tent floor to protect against abrasion
- When packing up, shake out dirt and sand as much as possible
- At home, clean your tent with a damp cloth, never use harsh cleaning chemicals, and air dry
- When storing, allow the tent to sit loosely to prevent creases